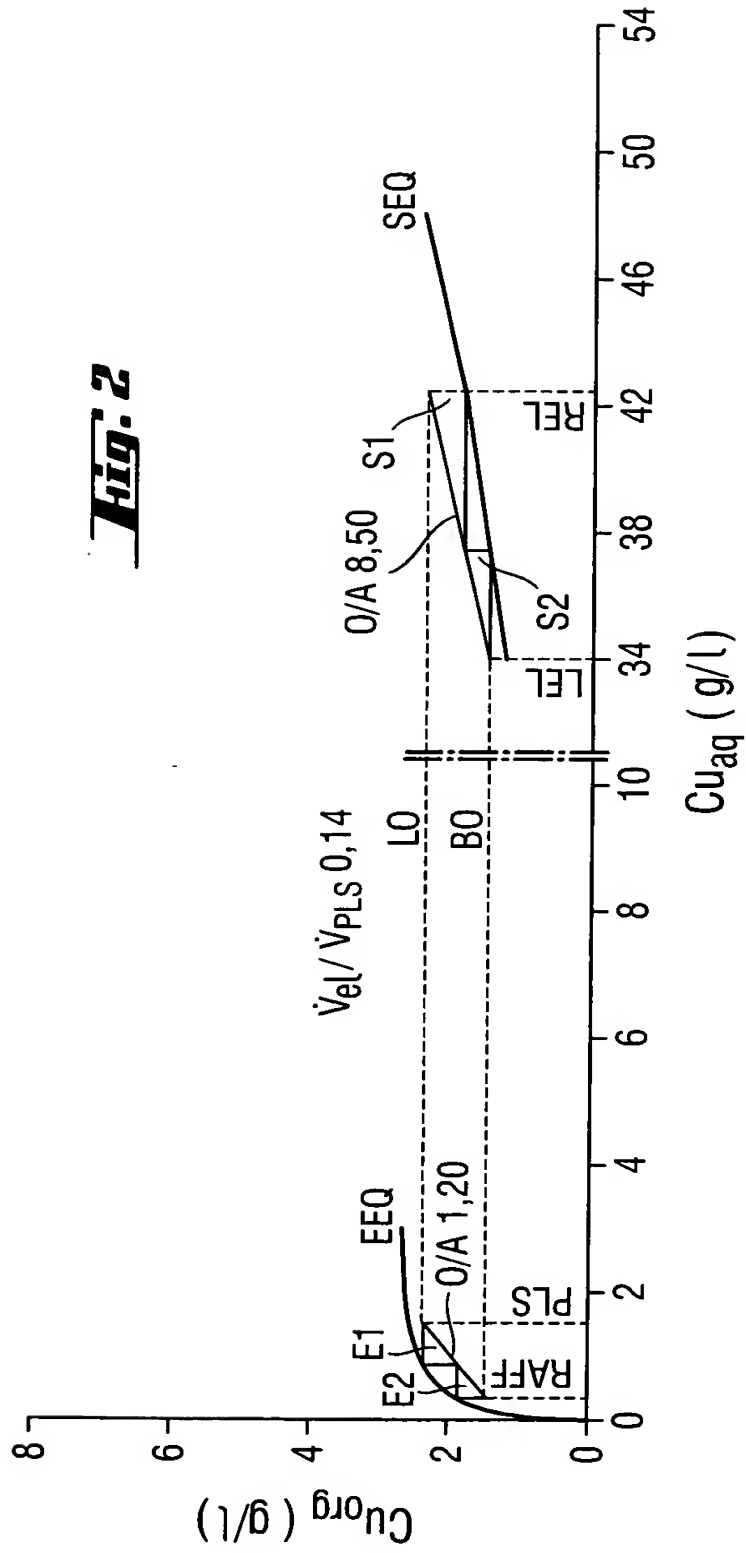

Fig. 1

Fig. 2



3 / 12

Fig. 3

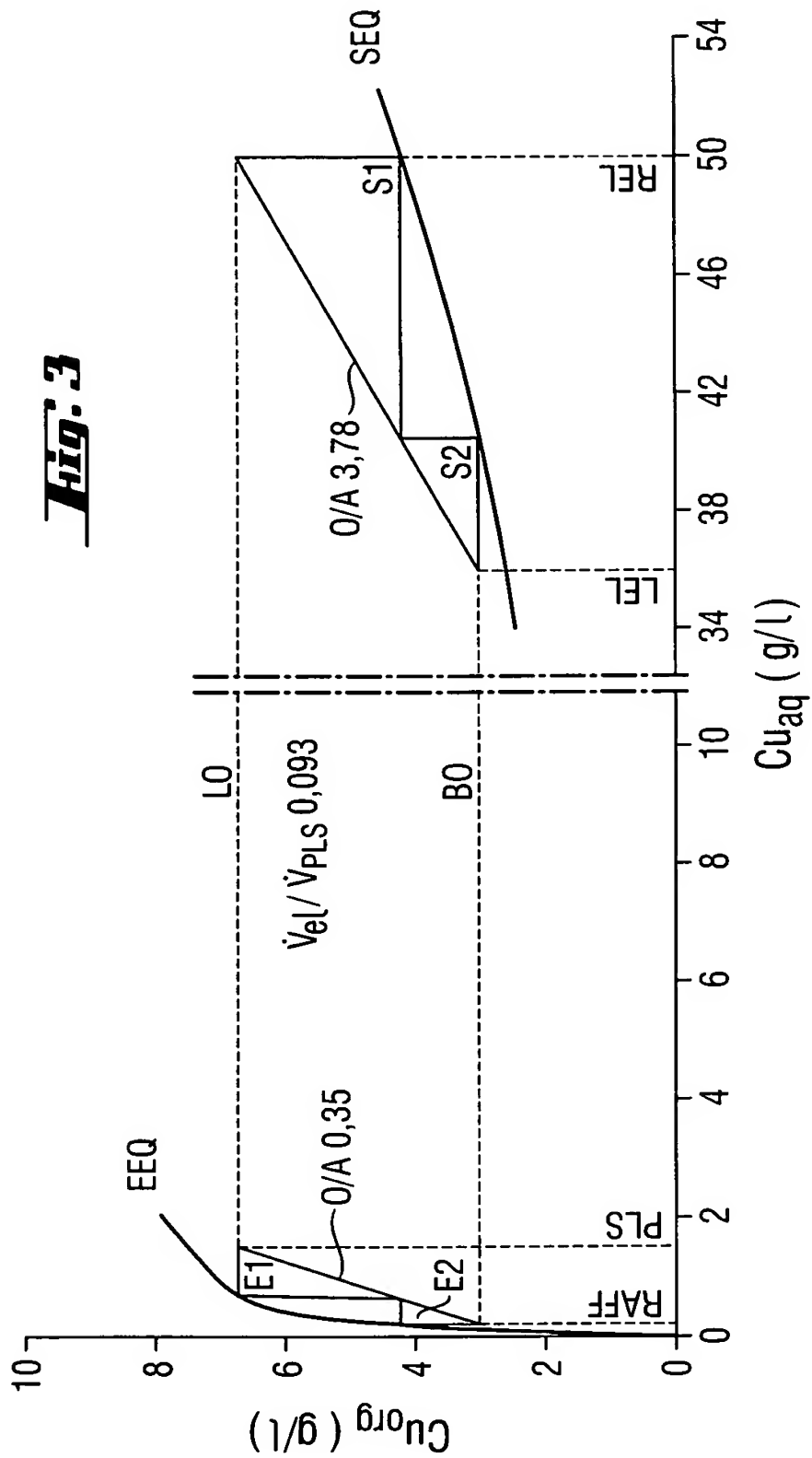
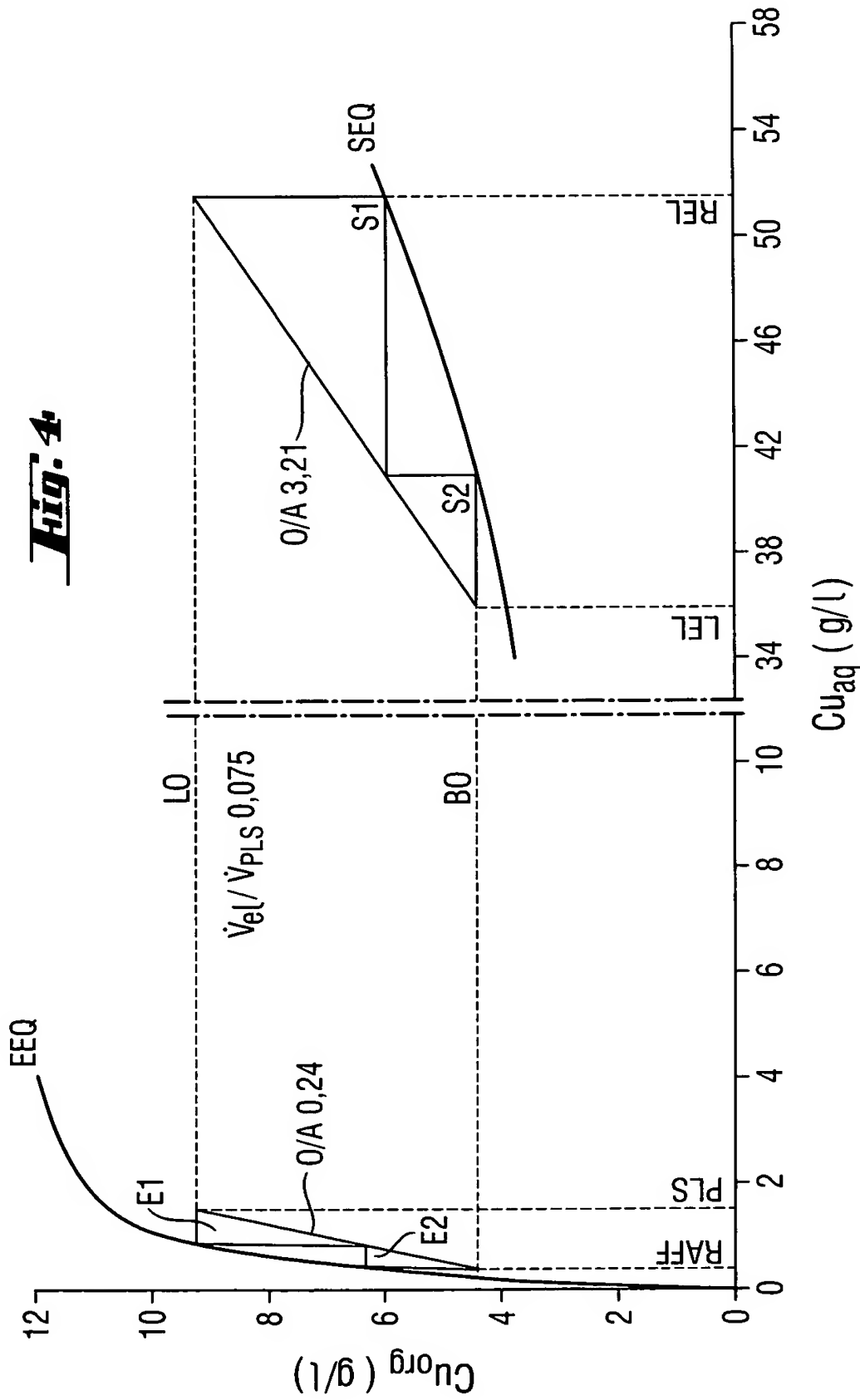
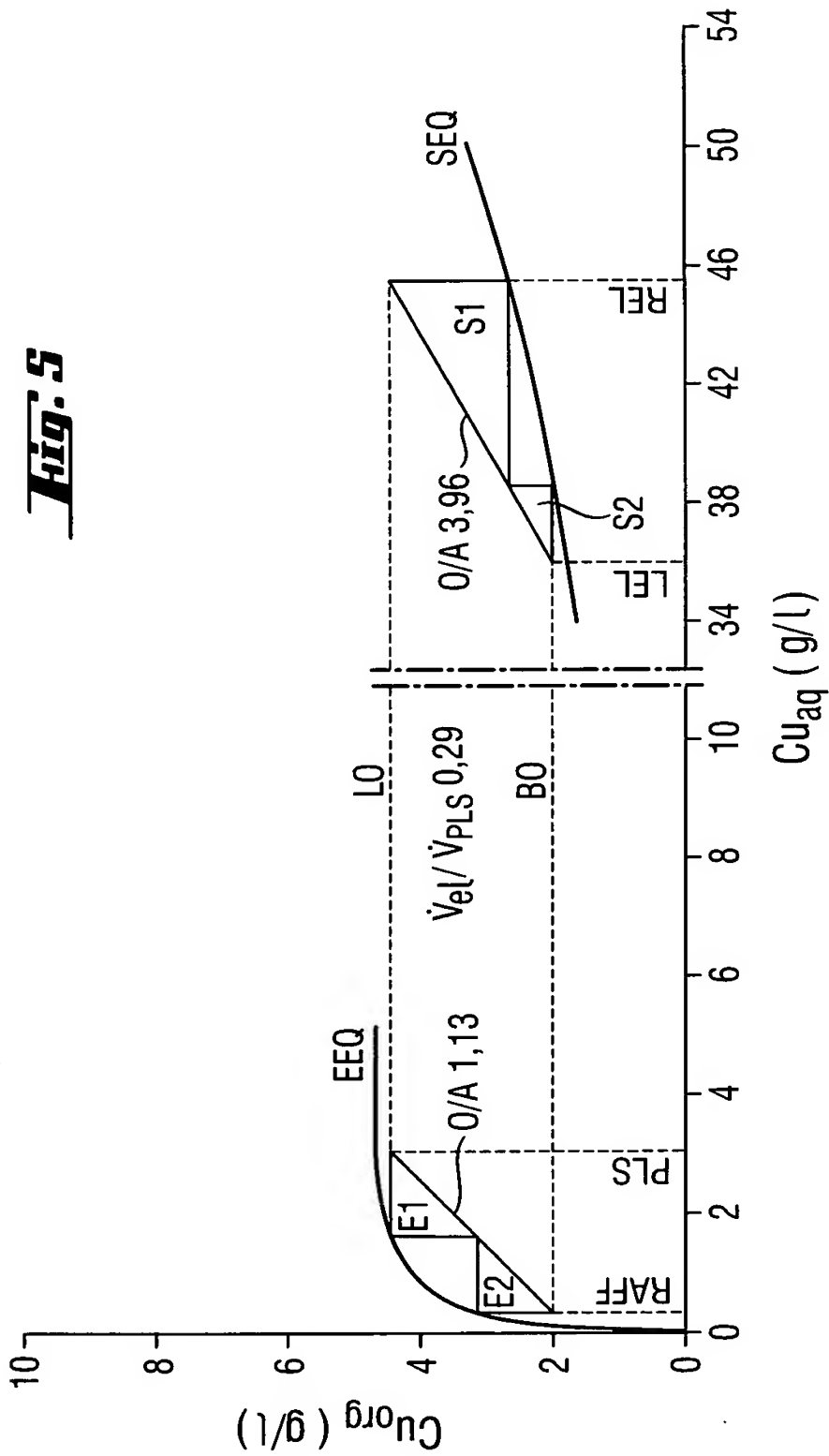

Fig. 4



5 / 12

Fig. 5



205040" 2966FOOT

Fig. 6

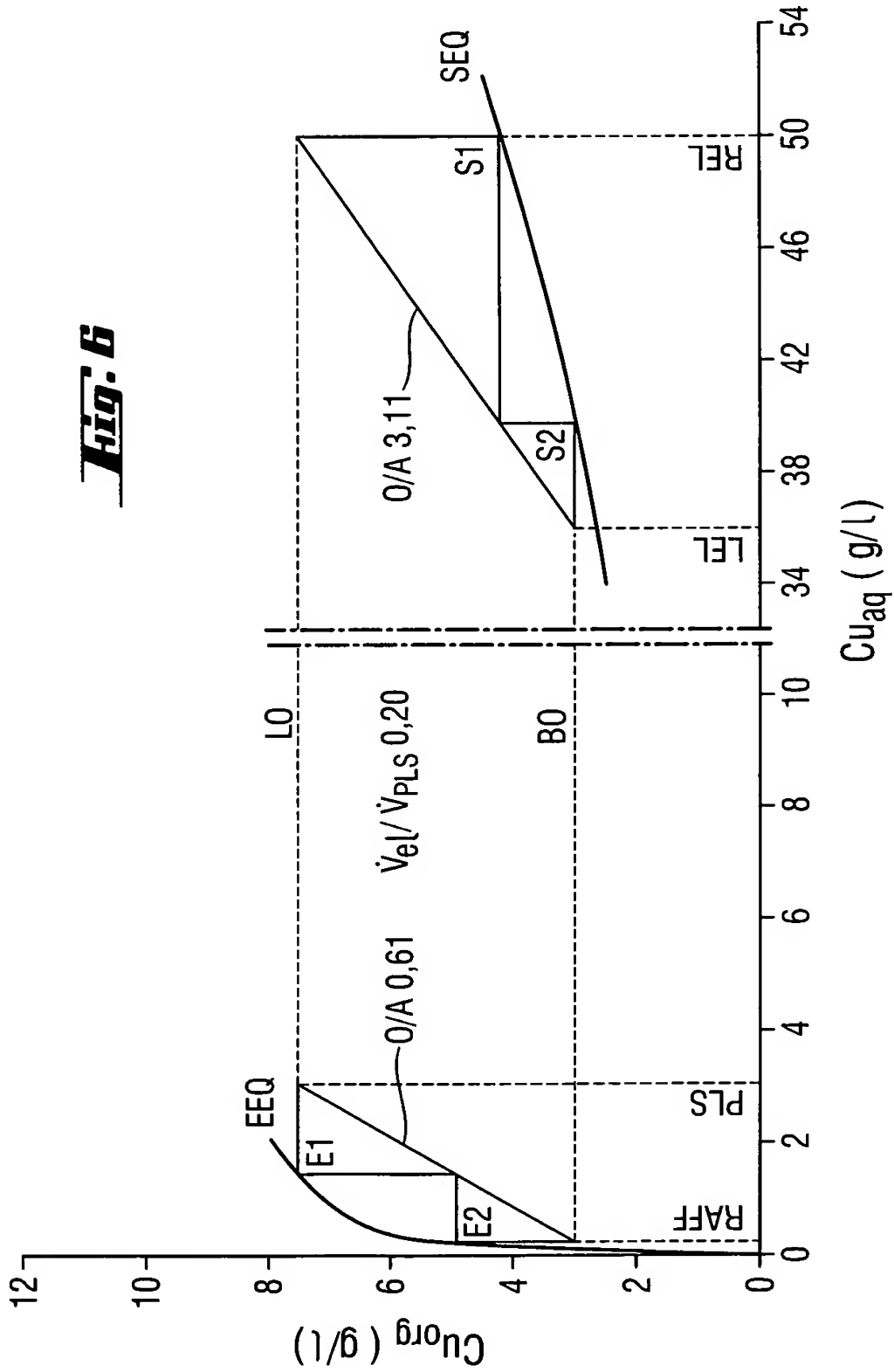

205040-2966T02F

Fig. 7

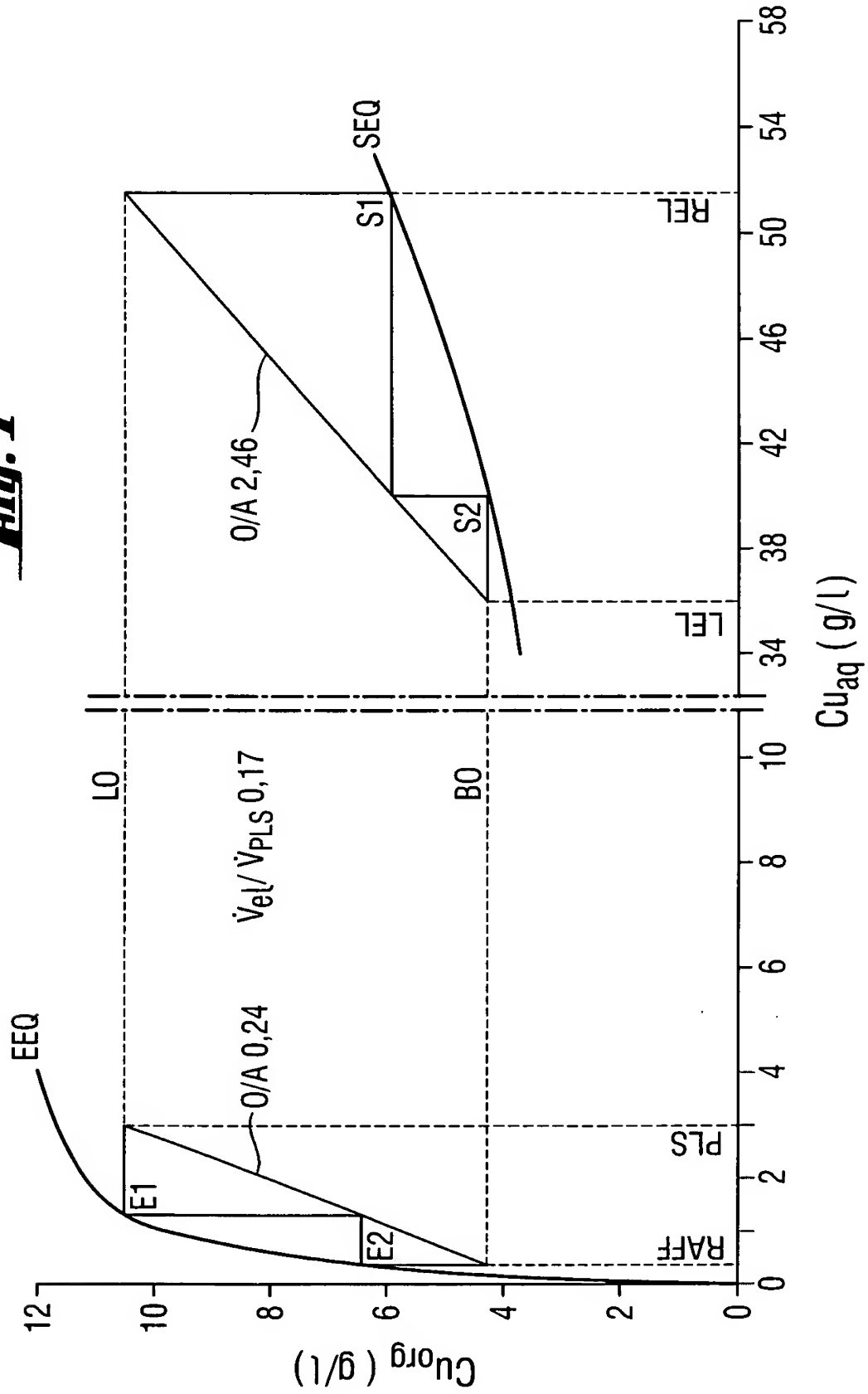
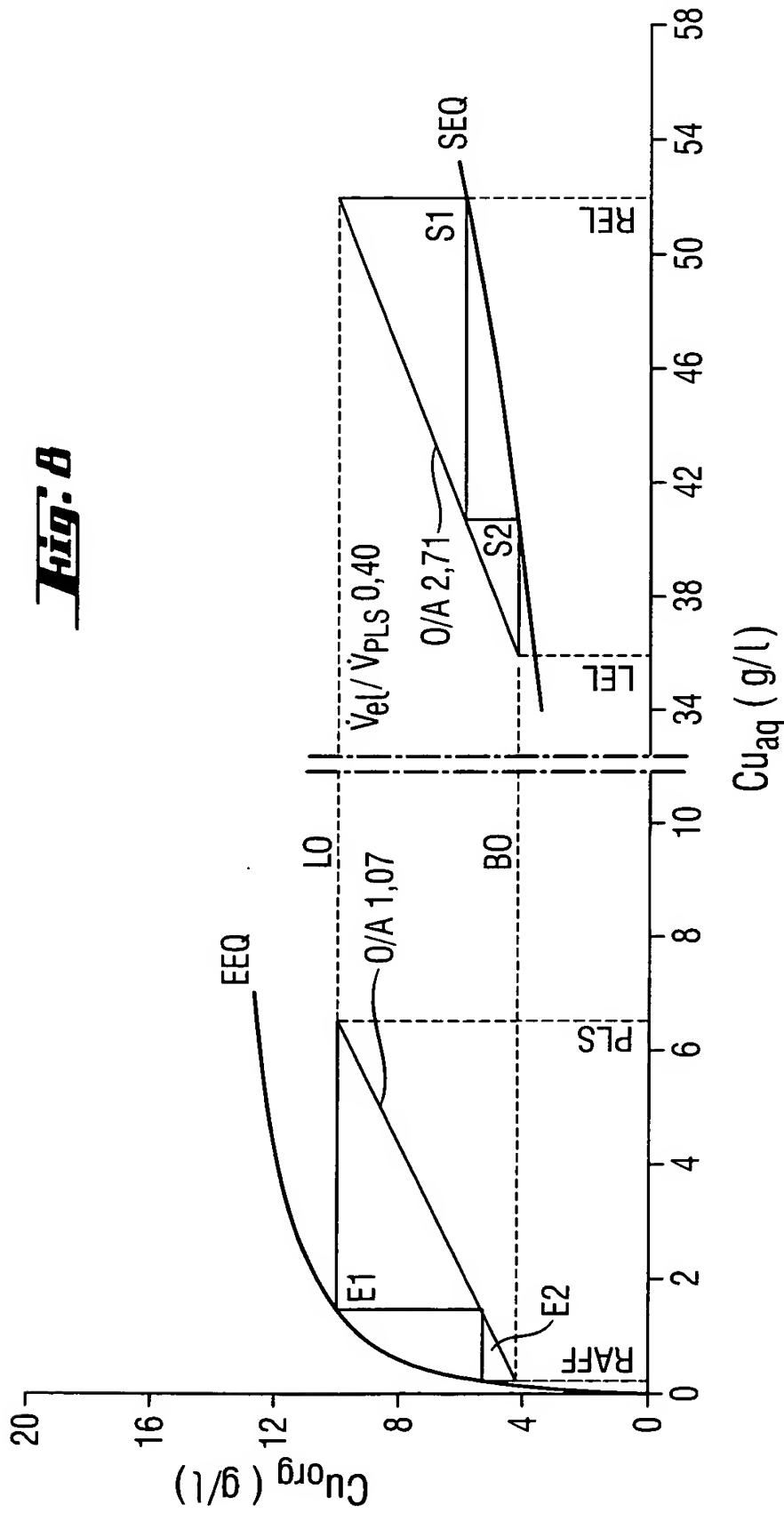
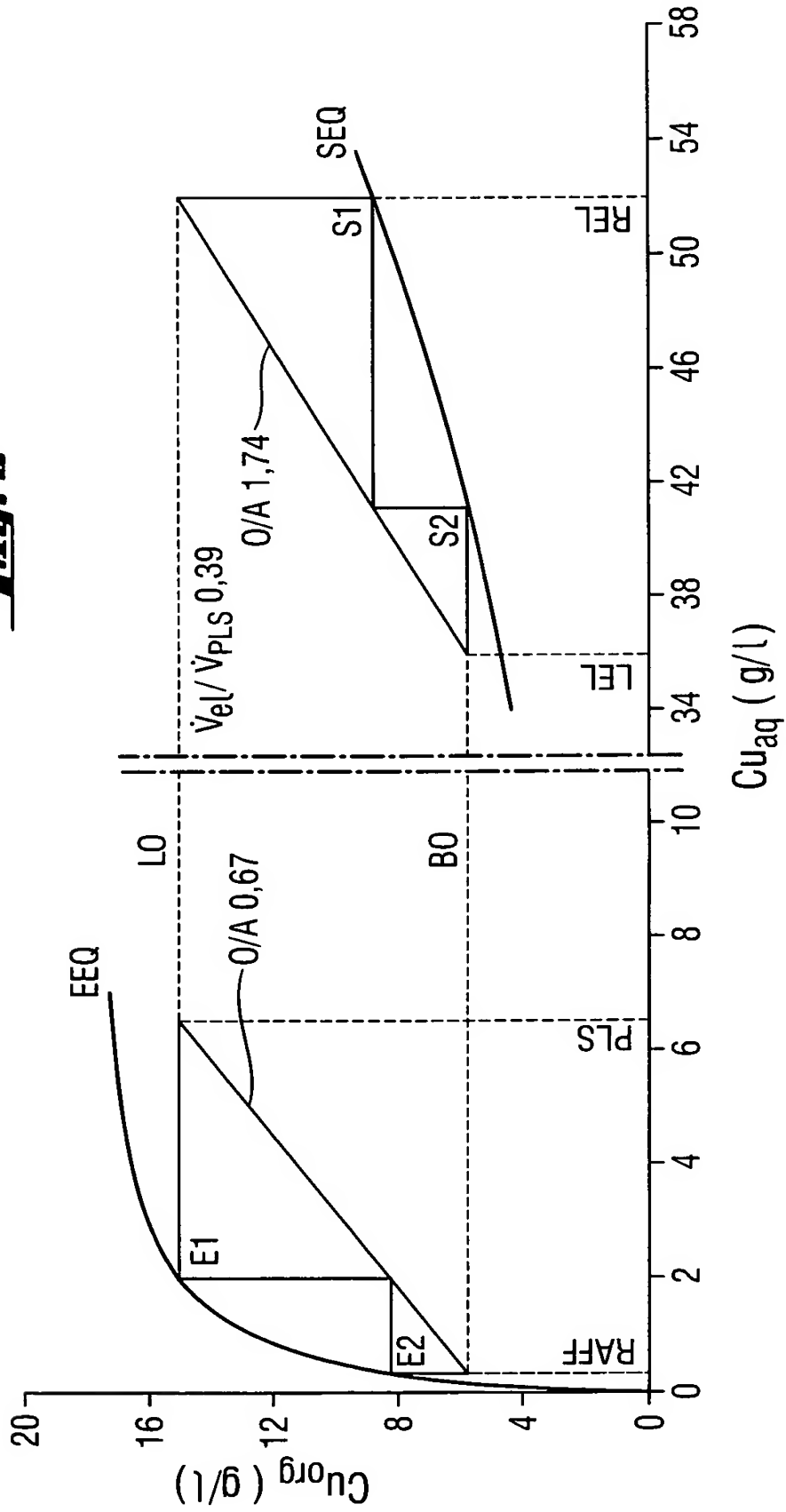

Fig. 8



9 / 12

Fig. 9



205040" 2966700F

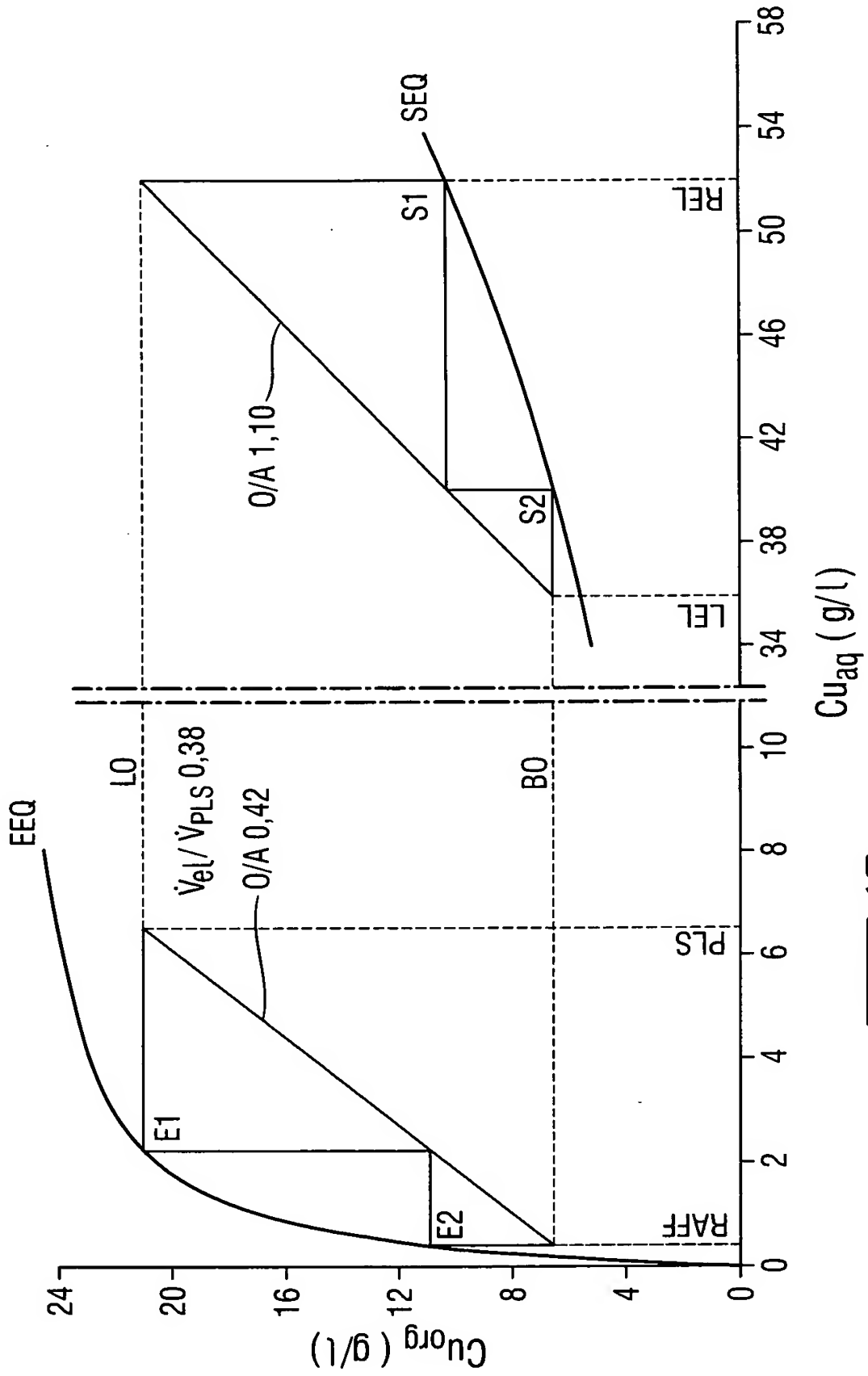

Fig. 10

205040 2965 F00F

Fig. 11

